



ECHO Yard Shield System

Instruction Manual

MODEL 99944200300

**To use as a blower only, refer to the Operator's Manual
included with the Power Blower unit.**



WARNING DANGER

Read rules for safe operation and all instructions carefully. ECHO provides this Instruction Manual which must be read and understood for proper and safe operation.

INTRODUCTION

Welcome to the ECHO family. This ECHO product was designed and manufactured to provide long life and on-the-job dependability. Read and understand this manual. You will find it easy to use and full of helpful operating tips and SAFETY messages.

THE INSTRUCTION MANUAL

Contains specifications and information for safety, assembly, operation, maintenance, storage, troubleshooting, and service specific to this product.

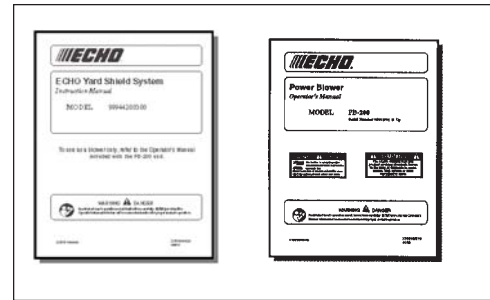

TABLE OF CONTENTS

Introduction	2
- The Instruction Manual	2
Operator Safety	3
Description	4
Contents	4
Assembly	5
- Converting Blower to Yard Shield System (PB-200)	5
- Converting Yard Shield System back to Blower (PB-200)	6
- Converting Blower to Yard Shield System (PB-251, PB-255, ES-255)	7
- Converting Yard Shield System back to Blower (PB-251, PB-255, ES-255)	8
Operation	10
- Mixing Instructions	10
- Application	11
Maintenance, Storage	13
Specifications	13
Servicing Information	16
- Parts	16
- Service	16
- Echo Consumer Product Support	16
- Warranty Registration	16
- Additional or Replacement Manuals	16

Specifications, descriptions and illustrative material in this literature are as accurate as known at the time of publication, but are subject to change without notice. Illustrations may include optional equipment and accessories, and may not include all standard equipment.

OPERATOR SAFETY



WARNING

- Before opening a chemical container, carefully read, understand, and follow all instructions on the label.
- Carefully read and understand the Operator's Manual supplied with this unit prior to filling, using, and/or cleaning this system.
- **DO NOT** use flammables or corrosives in the system. They can cause damage to the unit, ignite, or explode, causing serious injury.

CAUTION

Chemical Hazard. Do not ingest ECHO Yard Shield concentrate or diluted chemical mixture. Do not inhale chemical fumes or sprayed mist. Avoid contact with skin or eyes. Wear appropriate protective clothing and devices including mask, goggles, and gloves, when working with or around concentrate or diluted chemical mixture. Chemical causes eye irritation and is harmful if swallowed, inhaled, or absorbed through the skin.

- Use only ECHO Mosquito Yard Shield diluted agent with this system.
- Keep spray materials tightly capped, locked up, and out of reach of children and animals.
- Always inspect your system thoroughly before and after each use. Check to be sure pigtail hose is securely attached and in good condition before mixing chemical in the tank.
- Use only ECHO replacement parts.
- Do not spray on or near electrical installations.
- Keep the work area clear of people and animals.
- Never use the system during windy conditions.
- Do not eat, drink, or smoke while using the system.
- Only mix enough solution for your current application requirements.
- Mix chemical and fill tank on open ground away from blower.
- Do not store system with solution in tank for long periods of time.
- Do not transfer spray materials to other containers.
- Thoroughly clean and rinse tank and spraying assembly after each use.
- Wash thoroughly with soap and water after filling or using the system.

DESCRIPTION

Locate all safety decals on your unit. Make sure the decals are legible and that you understand and follow the instructions on them. If a decal cannot be read, a new one can be ordered from your ECHO dealer. See PARTS ORDERING instructions for specific information.

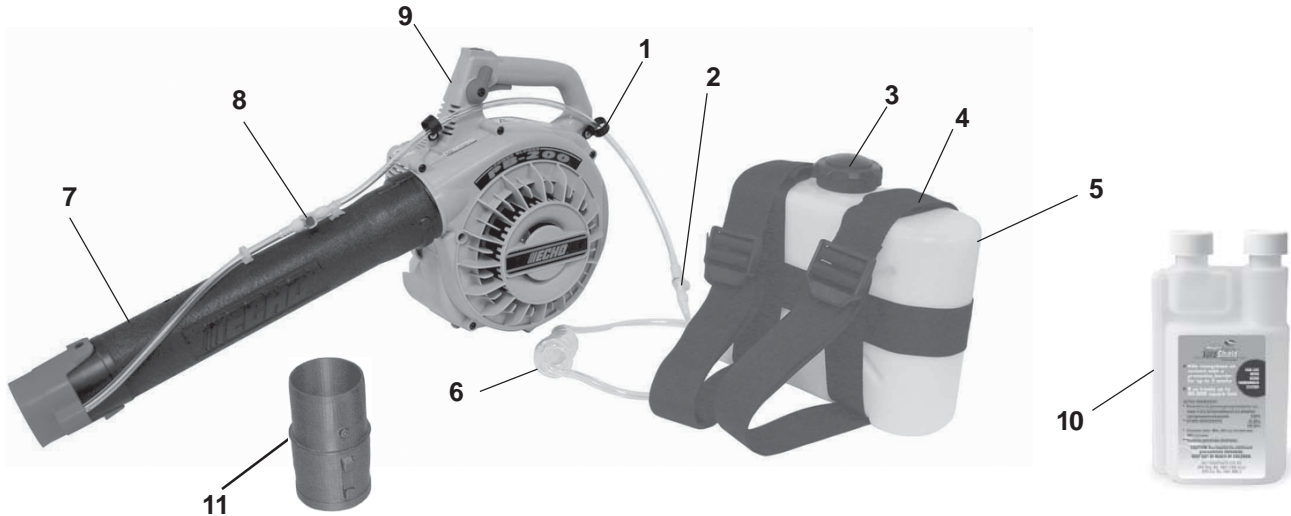

1. **HOSE GUIDES** - Route clear supply hose through guides to keep hose out of the way and provide consistent flow of Yard Shield agent.
2. **QUICK DISCONNECT** - Disconnect to refill tank with chemical solution.
3. **TANK CAP** - Covers and seals tank.
4. **ADJUSTABLE BACKPACK STRAPS** - Allows tank to fit comfortably on your back.
5. **BACKPACK TANK** - 1.5 gallon backpack tank holds enough diluted solution to cover up to 15,000 square feet.
6. **PIGTAIL HOSE** - Flexible hose provides easy mobility and reduces snagging
7. **PIPE / NOZZLE ASSEMBLY** - Pre-assembled and ready to install onto blower. Nozzle converts diluted agent into fine mist.
8. **SHUTOFF VALVE** - Conveniently located shut off valve immediately stops flow to nozzle.
9. **ECHO PB-200 GAS-POWERED BLOWER** - May or may not be included with Yard Shield kit
10. **YARDSHIELD CONCENTRATE** - Provided separately. P/N 99944200310
11. **BLOWER TUBE ADAPTER** - Install blower tube adapter to use Yard Shield with PB-251.

CONTENTS

- _____ Backpack tank / hose with quick disconnect valve
- _____ Yard Shield pipe/nozzle assembly
- _____ 2 Hose guides
- _____ 2 Thumb snaps
- _____ Tube Adapter
- _____ Instruction Sheet



ASSEMBLY

CONVERTING BLOWER TO YARD SHIELD SYSTEM (PB-200)

1. Turn blower pipes counter clockwise to remove from blower.



2. Attach hose guides (A) to each of the two holes on PB-200 handle. Secure hose guides by pushing thumb snaps into place.



3. Align grooves in Yard Shield pipe with pegs on blower housing and slide Yard Shield pipe onto housing. Twist pipe clockwise to lock into place. Assure clear hose runs along top of pipe.

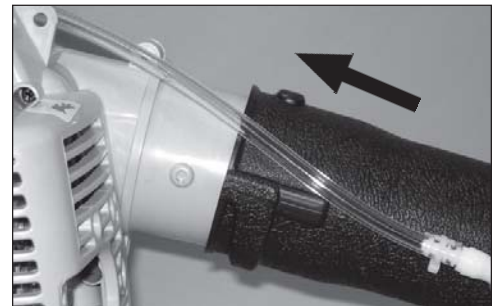

Tip: For best results, do not use Yard Shield pipe for blower-only application.

4. Route supply hose through hose guides, toward back of blower.



5. Attach hose to tank hose at quick disconnect valve.

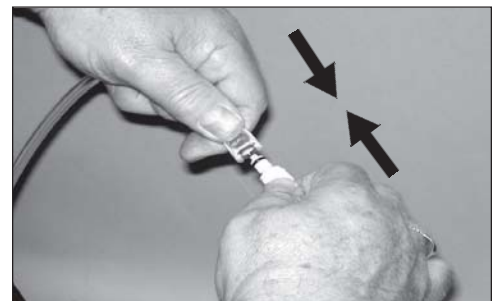

CONVERTING YARD SHIELD SYSTEM BACK TO BLOWER (PB-200)

1. Thoroughly clean and rinse tank and spraying assembly after each use.
2. Disconnect supply hose from tank hose at quick disconnect valve.

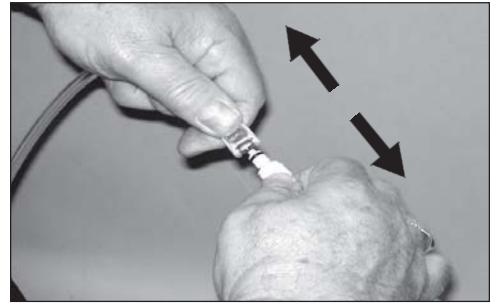

3. Remove supply hose from hose guides.

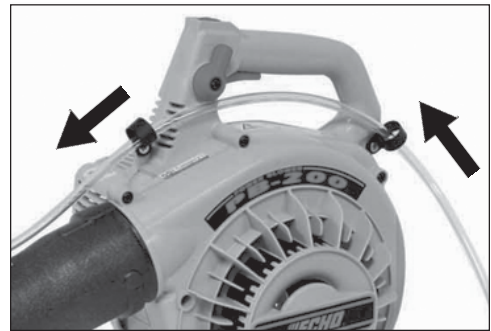

4. Remove Yard Shield pipe by turning counter clockwise.

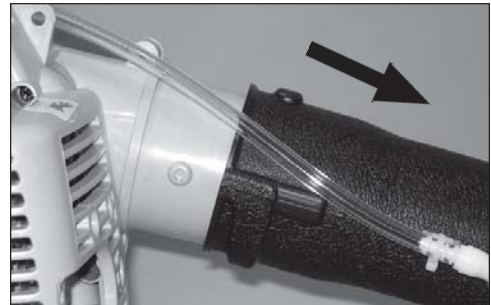

5. See PB-200 Operator's Manual for instructions on installing blower pipes.

CONVERTING BLOWER TO YARD SHIELD SYSTEM (PB-251)

1. Release locking ring (C) with a coin or screwdriver, and rotate ring counter clockwise so that lock symbol (A) is at top of ring.
2. Remove blower pipes from locking ring.

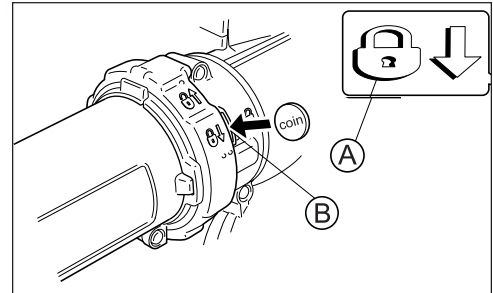

3. Align locking ribs (D) on blower pipe adapter with recesses in locking ring, and slide adapter into locking ring.

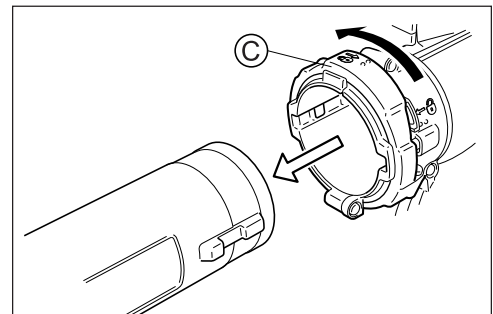

4. Rotate locking ring (C) clockwise 1/8 turn to lock adapter in place.

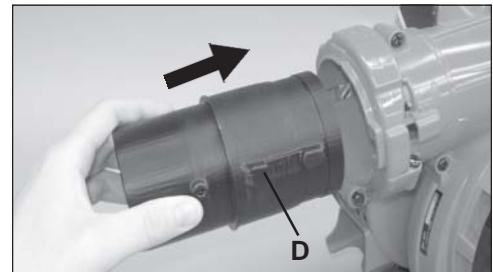

5. Align grooves in Yard Shield pipe with pegs (E) on blower pipe adapter and slide Yard Shield pipe onto adapter. Twist pipe clockwise to lock into place. Assure clear hose runs along top of pipe.

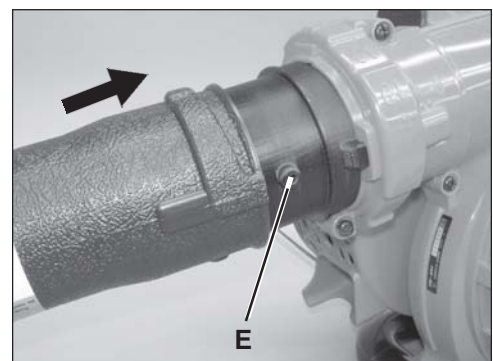
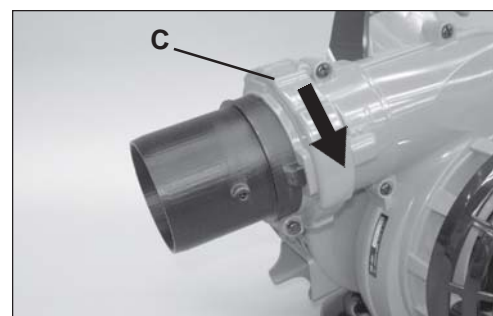

6. Route supply hose through handle, toward back of blower.



7. Attach hose to tank hose at quick disconnect valve.

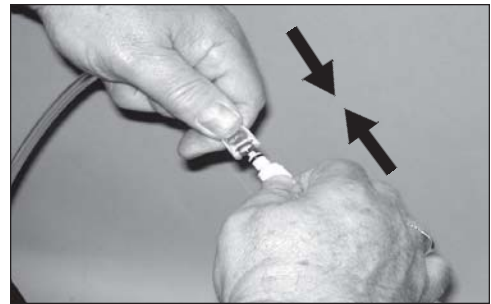

CONVERTING YARD SHIELD SYSTEM BACK TO BLOWER (PB-251)

1. Disconnect supply hose from tank hose at quick disconnect valve.

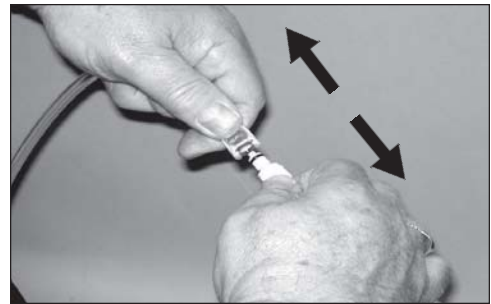

2. Remove supply hose from handle.



3. Remove Yard Shield pipe by turning counter clockwise.



4. Release locking ring (C) with a coin or screwdriver, and turn ring counter clockwise so that lock symbol (A) is at top of ring.

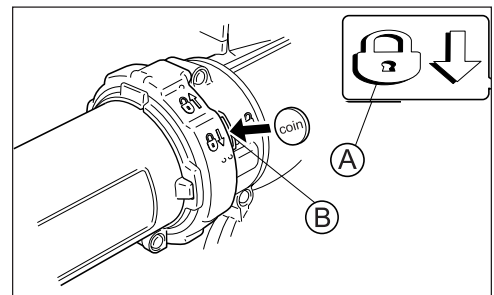

5. Remove adapter from locking ring (C).



6. See Power Blower Operator's Manual for instructions on installing blower pipes.

OPERATION

MIXING INSTRUCTIONS

YARDSHIELD CHEMICAL CONCENTRATE
 PRECAUTIONARY STATEMENTS
HAZARDS TO HUMANS AND DOMESTIC ANIMALS

CAUTION

Causes eye irritation. Harmful if swallowed, inhaled, or absorbed through skin. Avoid contact with skin, eyes, or clothing. Avoid breathing vapor or spray mist. Wash thoroughly with soap and water after handling and before eating, drinking, chewing gum, or using tobacco. Remove and wash contaminated clothing before reuse.

ENVIRONMENTAL HAZARDS

This pesticide is extremely toxic to fish. Do not apply directly to water. Do not contaminate water when disposing of equipment wash waters or rinsate. Drift and runoff may be hazardous to aquatic organisms in water adjacent to treated areas. This product is highly toxic to bees exposed to direct treatment on blooming crops or weeds. Do not apply this product or allow it to drift to blooming crops or weeds while bees are actively visiting the treatment area.

YARDSHIELD CHEMICAL CONCENTRATE FIRST AID	
IF SWALLOWED:	<ul style="list-style-type: none"> •Immediately call a poison control center or doctor. •Do not induce vomiting unless told to do so by a poison control center or doctor. •Do not give any liquid to the person. •Do not give anything by mouth to an unconscious person.
IF IN EYES:	<ul style="list-style-type: none"> •Hold eye open and rinse slowly and gently with water for 15 – 20 minutes. •Remove contact lenses, if present, after the first 5 minutes. •Call a poison control center or doctor for treatment advice.
IF ON SKIN OR CLOTHING:	<ul style="list-style-type: none"> •Take off contaminated clothing. •Rinse skin immediately with plenty of water for 15 – 20 minutes. •Call a poison control center or doctor for treatment advice.
IF INHALED:	<ul style="list-style-type: none"> •Remove affected person to fresh air. •If person is not breathing, call 911 or an ambulance, then give artificial respiration, preferably mouth-to-mouth if possible. •Call a poison control center or doctor for further treatment advice.
<p>Have the product container or label with you when calling a poison control center or doctor, or going for treatment. For information regarding medical emergencies or pesticide incidents, call the International Poison Center at 1-888-740-8712.</p>	

CAUTION

Chemical hazard. Wear appropriate protective clothing and devices when working with ECHO Yard Shield concentrate. Chemical causes eye irritation and is harmful if swallowed, inhaled, or absorbed through the skin.

1. Disconnect quick disconnect valve (A) by pushing silver button.

CAUTION

To prevent leaking, mix chemical while tank pigtail hose is disconnected from blower.

2. Remove cap from tank. To mix a full tank, pour 1.25 ounces of Yard Shield concentrate into tank. Fill tank with water to 1.5 gallon mark. Use graduation marks on concentrate bottle and backpack tank to mix less than a full tank of solution. Mix only as much as you will use in one session.

3. Replace cap.

CAUTION

Spilling hazard. Tank must remain upright at all times, otherwise contents may leak from cap.

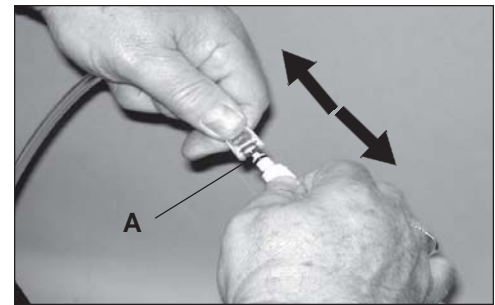

Mixing Ratios

Water	Concentrate
1.5 gal.	1.25 oz.
1 gal.	.83 oz.
.5 gal.	.41 oz.

APPLICATION



WARNING

Chemical hazard. Chemical causes eye irritation and is harmful if swallowed, inhaled, or absorbed through the skin. Wear appropriate protective clothing and devices when working with ECHO Yard Shield System. Do not spray on or near people or animals. Allow sprayed area to dry completely before permitting people or animals to enter.

CAUTION

Chemical can blow and drift. Apply on calm days. Otherwise, sprayed chemical can drift up to 150 meters, causing unintentional contact.

A full tank of Yard Shield mixture will cover 15,000 square feet.

Aim blower at the ground, bushes, shrubs, hard-to-reach places, and mosquito breeding grounds. For best results, position blower 3 - 6 feet from area to be treated and use blower at wide open throttle.

Progress at a normal walking pace, sweeping blower in a side to side motion, always overlapping passes. Avoid walking directly into spray. Apply until surfaces are wet but not dripping. People and pets may safely return to area after application is dry.

Yard Shield will remain effective for up to 3 weeks, as long as surfaces remain dry. Precipitation will wash Yard Shield away.

1. Push silver button on shutoff valve (B) to disengage valve, and prevent chemical flow.
2. Start blower. (See PB-200 operator's manual for step by step instructions on starting and stopping.)
3. Put backpack on back, and adjust straps for comfortable fit.
4. Set blower to half speed or higher.
5. Connect tank hose to clear hose on blower at quick disconnect valve (A).

NOTE

Assure blower is operating at half speed or higher before engaging shutoff valve (B).

6. Engage shutoff valve (B) to start chemical flow, and begin spraying.

NOTE

Chemical flow is gravity-fed. Flow will begin when shutoff valve is connected and backpack is positioned higher than blower.

Stopping Procedure

1. Push silver button on shutoff valve (B) to disengage valve and stop chemical flow.
2. Turn blower engine off (Refer to PB-200 operator's manual.)
3. Disconnect quick disconnect valve (A).

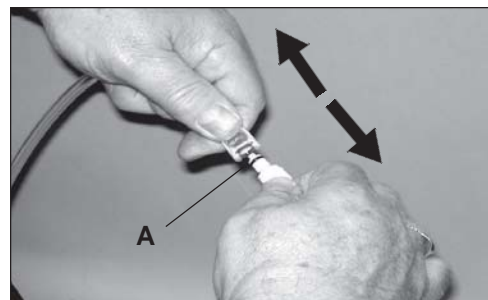
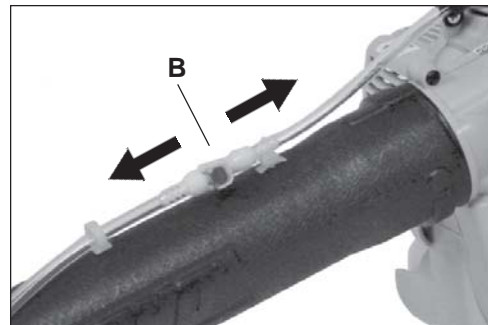
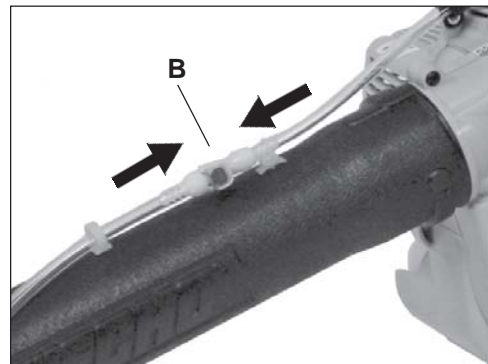
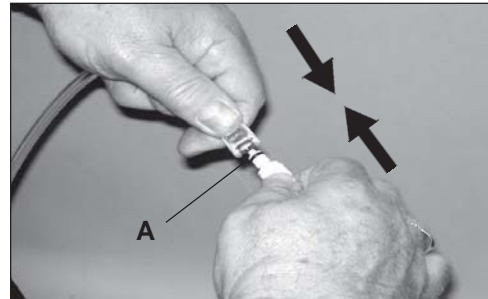
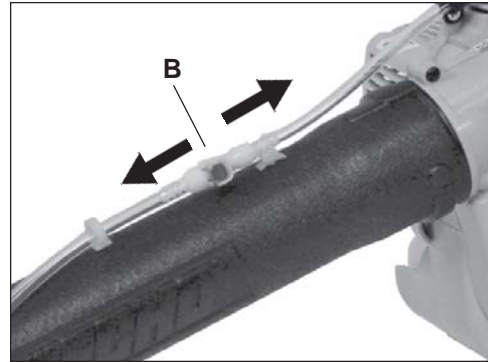

MAINTENANCE, STORAGE

(According to M86 Web Site (ECHO FAQ's) you can!)

1. After each use, remove cap and rinse tank thoroughly with clean water.

CAUTION

Never pour pesticides down the toilet drain, into the gutter, or on the ground.

2. Add water to tank and operate system to flush completely.
3. Allow entire system to dry thoroughly before storing.
4. Always store tank clean and empty in a cool, dry location.
5. Follow instructions for engine storage in PB-200 Operator's Manual.

SPECIFICATIONS

Flow Rate 5.3 oz. / minute @ wide open throttle

Spray Type Fine mist, non-adjustable

Tank Capacity 1.5 gallons

Dilution Rate 1.25 oz. Yard Shield Concentrate / 1.5 gallons water

Drying Time Approximately 1 - 4 hours, depending on temperature & humidity

Chemical Specifications:

ACTIVE INGREDIENT:

*Permethrin (3-phenoxyphenyl)methyl(±)-cis,
trans-3-(2,2-dichloroethyl)-2,2-dimethylcyclopr
opancarboxylate 9.00%

**OTHER INGREDIENTS 91.00%

100.00%

*Cis,trans ratio: Min. 35% (±) cis and max 65% (±) trans

**Contains petroleum distillates

NOTES

NOTES

SERVICING INFORMATION

PARTS

Genuine ECHO Parts and ECHO REPOWER™ Parts and Assemblies for your ECHO products are available only from an Authorized ECHO Dealer. When you do need to buy parts, **always** have the Model Name and Number on the front of this manual. (See your Operator's Manual for Model and Serial Number information to order blower parts. For future reference, write the model number in the space provided below.

Model No. _____

SERVICE

Service of this product during the warranty period must be performed by an Authorized ECHO Service Dealer. For the name and address of the Authorized ECHO Service Dealer nearest you, ask your retailer or call: 1-800-432-ECHO (3246). Dealer information is also available on our Web Site. When presenting your unit for Warranty service/repairs, proof of purchase is required.

ECHO CONSUMER PRODUCT SUPPORT

If you require assistance or have questions concerning the application, operation or maintenance of this product you may call the ECHO Consumer Product Support Department at 1-800-673-1558 from 8:30 am to 4:30 pm (Central Standard Time) Monday through Friday. Before calling, please know the model and serial number of your unit to help your Consumer Product Support Representative.

WARRANTY REGISTRATION

To ensure trouble free warranty coverage it is important that you register your ECHO equipment on-line at www.echo-usa.com. Other registration options are by automated phone at 1-800-432-3246 or by filling out the warranty registration card supplied with your unit. Registering your product confirms your warranty coverage and provides a direct link between you and ECHO if we find it necessary to contact you.

ADDITIONAL OR REPLACEMENT MANUALS

Operator's and Parts Manuals are available by:

- Downloading free from www.echo-usa.com
- Purchasing from your Echo Dealer.
- Sending a check or money order for \$2.00 per Parts Catalog or \$1.50 per Operator's Manual made payable to ECHO, INCORPORATED. State on a sheet of paper the model number of the ECHO unit you have, part number of the manual (if known), your name and address, and mail to the address below.

DEALER?

Call
1-800-432-ECHO
or
www.echo-usa.com

CONSUMER PRODUCT SUPPORT

1-800-673-1558
8:30 - 4:30 Mon - Fri C.S.T.

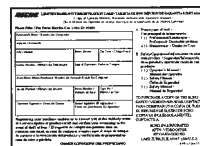

ECHO®

ECHO, INCORPORATED

400 Oakwood Road
Lake Zurich, IL 60047

WWW.ECHO-USA.COM